

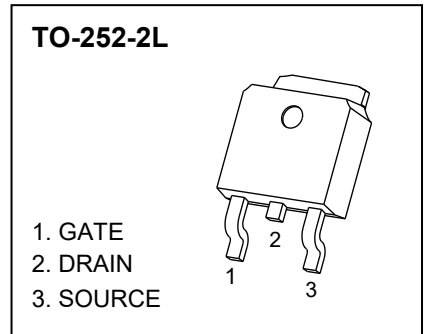

## TO-252-2L Plastic-Encapsulate MOSFETS

### U50SN10 N-Channel Power MOSFET

$V_{(BR)DSS}$	$R_{DS(on)TYP}$	$I_D$
100V	16.5mΩ@10V	50A



#### DESCRIPTION

The U50SN10 uses shielded gate trench technology and design to provide excellent  $R_{DS(ON)}$  with low gate charge. It can be used in a wide variety of applications

#### FEATURES

- High Power and current handling capability
- Load switch
- High density cell design for ultra low  $R_{DS(ON)}$
- Lead free product is acquired
- Good stability and uniformity with high  $E_{AS}$
- Excellent package for good heat dissipation

#### APPLICATIONS

- SMPS and general purpose applications
- Hard switched and high frequency circuits
- Uninterruptible Power Supply
- Power management

#### MARKING

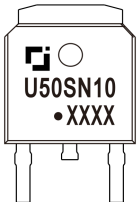

U50SN10= Device code  
Solid dot = Green molding compound device,  
if none, the normal device  
XXXX=Code

#### EQUIVALENT CIRCUIT

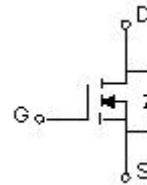

#### ABSOLUTE MAXIMUM RATINGS ( $T_a=25^\circ\text{C}$ unless otherwise noted)

Parameter	Symbol	Value	Unit
Drain-Source Voltage	$V_{DS}$	100	V
Gate-Source Voltage	$V_{GS}$	±20	
Continuous Drain Current	$I_D$	50	A
Pulsed Drain Current <sup>(1)</sup>	$I_{DM}$	170	
Maximum Power Dissipation <sup>(4)</sup>	$P_D$	50	W
Avalanche energy*	$E_{AS}$	80	mJ
Thermal Resistance from Junction to Case	$R_{\theta JC}$	2.5	$^\circ\text{C/W}$
Thermal Resistance from Junction to Ambient <sup>(3)</sup>	$R_{\theta JA}$	62	$^\circ\text{C/W}$
Junction Temperature	$T_J$	150	$^\circ\text{C}$
Storage Temperature	$T_{STG}$	-55~ +150	

\* EAS test condition  $V_{DD}=50\text{V}$ ,  $R_G=25\ \Omega$ ,  $L=0.3\ \text{mH}$ , starting  $T_J=25\ ^\circ\text{C}$ .

## MOSFET ELECTRICAL CHARACTERISTICS

$T_a=25\text{ }^\circ\text{C}$  unless otherwise specified

Parameter	Symbol	Test Condition	Min	Type	Max	Unit
<b>Static Characteristics</b>						
Drain-source breakdown voltage	$V_{(BR)DSS}$	$V_{GS} = 0V, I_D = 250\mu A$	100			V
Zero gate voltage drain current	$I_{DSS}$	$V_{DS} = 100V, V_{GS} = 0V$			1	$\mu A$
Gate-body leakage current	$I_{GSS}$	$V_{GS} = \pm 20V, V_{DS} = 0V$			$\pm 100$	nA
Gate threshold voltage <sup>(1)</sup>	$V_{GS(th)}$	$V_{DS} = V_{GS}, I_D = 250\mu A$	1.0	1.7	2.5	V
Drain-source on-resistance <sup>(1)</sup>	$R_{DS(on)}$	$V_{GS} = 10V, I_D = 10A$		16.5	22	m $\Omega$
Forward transconductance <sup>(1)</sup>	$g_{FS}$	$V_{DS} = 5.0V, I_D = 20A$		51		S
<b>Dynamic characteristics<sup>(2)</sup></b>						
Total gate charge	$Q_g$	$V_{DS} = 50V, V_{GS} = 10V, I_D = 5A$		15.7		nC
Gate-source charge	$Q_{gs}$			2.6		
Gate-drain charge	$Q_{gd}$			4.0		
Input Capacitance	$C_{iss}$	$V_{DS} = 50V, V_{GS} = 0V, f = 100kHz$		975.3		pF
Output Capacitance	$C_{oss}$			175		
Reverse Transfer Capacitance	$C_{rss}$			9.4		
<b>SWITCHING PARAMETERS<sup>(2)</sup></b>						
Turn-on delay time	$t_{d(on)}$	$V_{GS} = 10V, V_{DS} = 50V,$ $R_G = 10\Omega, I_D = 5A$		16.5		ns
Turn-on rise time	$t_r$			3.7		
Turn-off delay time	$t_{d(off)}$			64.7		
Turn-off fall time	$t_f$			44		
<b>Source-Drain Diode characteristics<sup>(1)</sup></b>						
Body diode voltage	$V_{SD}$	$I_S = 20A, V_{GS} = 0V$			1.3	V

### Notes:

1. Pulse Test : Pulse width  $\leq 300\mu s$ , duty cycle  $\leq 0.5\%$ .
2. Guaranteed by design, not subject to production testing.
3. The value of  $R_{\theta JA}$  is measured with the device mounted on 1 in 2 FR-4 board with 2oz. Copper, in a still air environment with  $T_a = 25\text{ }^\circ\text{C}$ .
4. Pd is based on max. junction temperature, using junction-case thermal resistance.

# Typical Characteristics

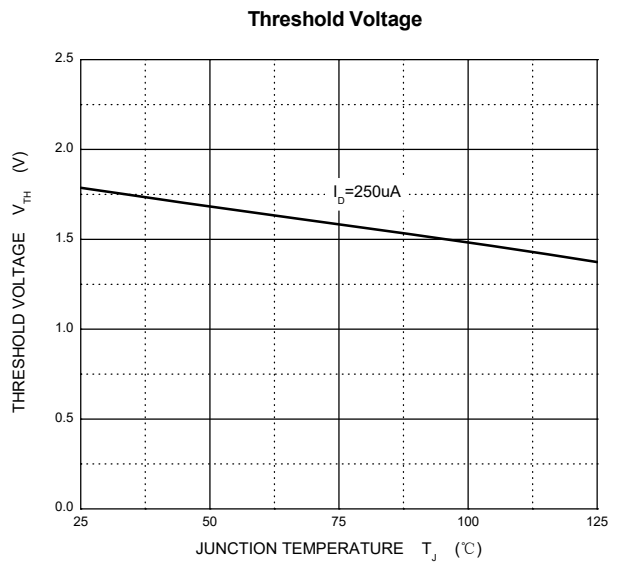
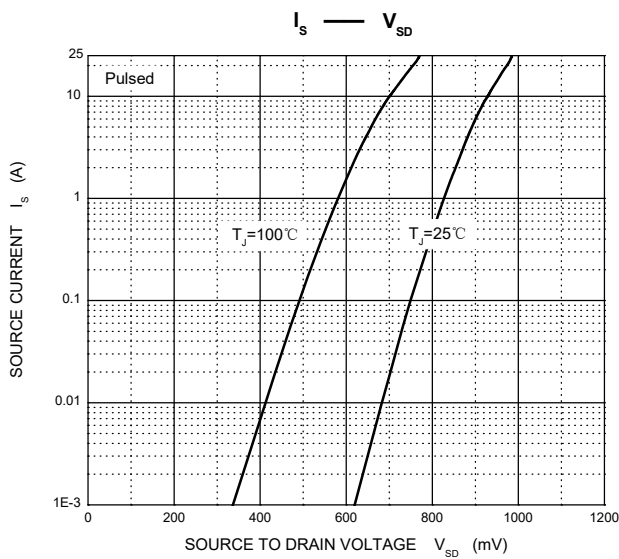
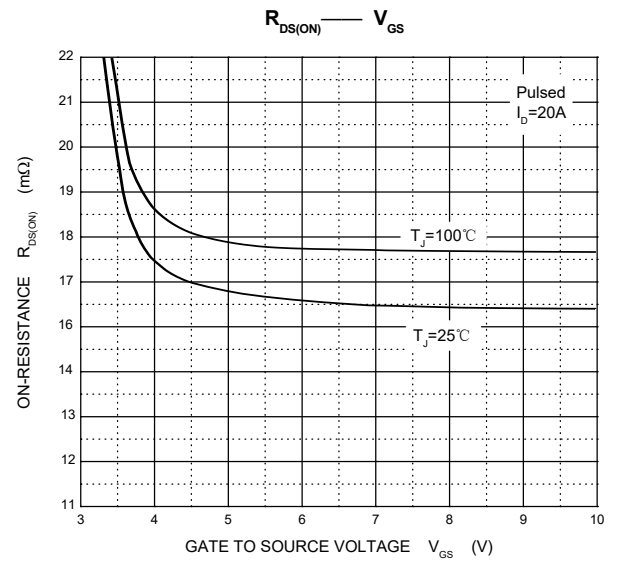
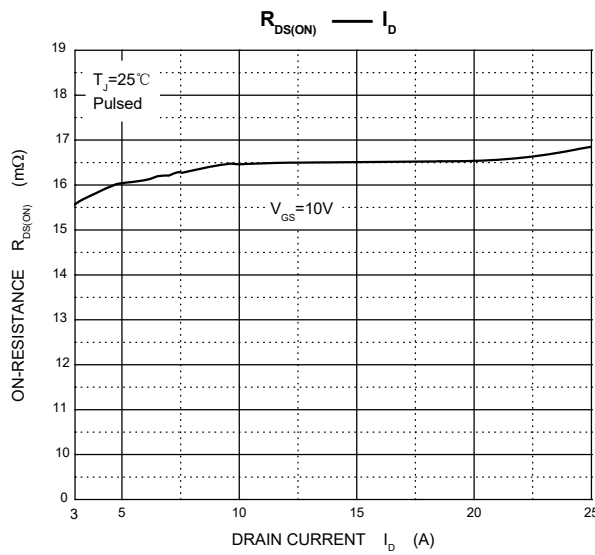
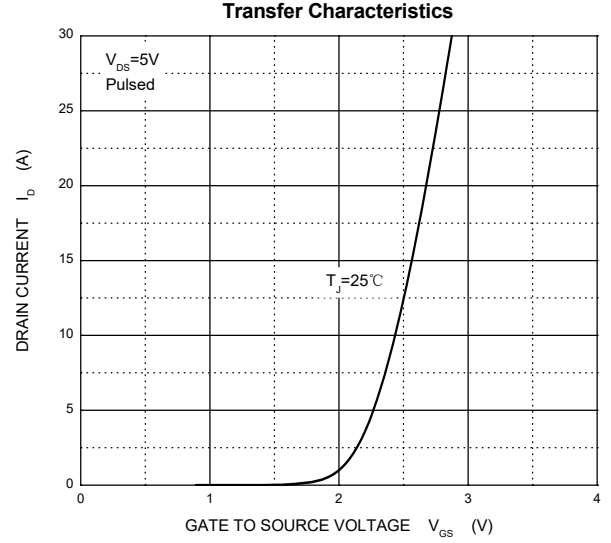
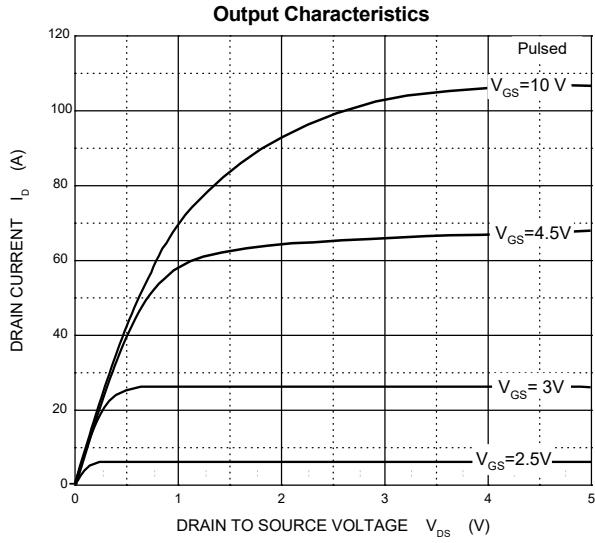

## TO-252-2L Package Outline Dimensions

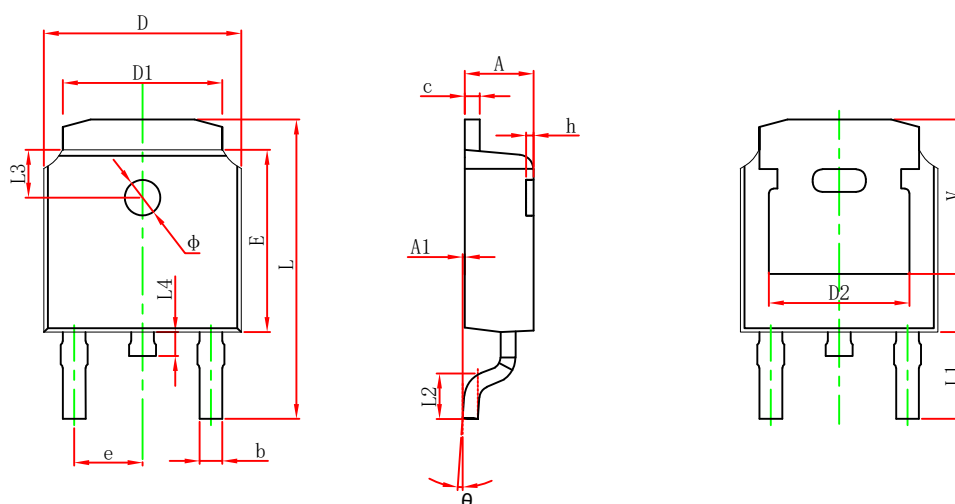

Symbol	Dimensions In Millimeters		Dimensions In Inches	
	Min.	Max.	Min.	Max.
A	2.200	2.400	0.087	0.094
A1	0.000	0.127	0.000	0.005
b	0.635	0.770	0.025	0.030
c	0.460	0.580	0.018	0.023
D	6.500	6.700	0.256	0.264
D1	5.100	5.460	0.201	0.215
D2	4.830 REF.		0.190 REF.	
E	6.000	6.200	0.236	0.244
e	2.186	2.386	0.086	0.094
L	9.712	10.312	0.382	0.406
L1	2.900 REF.		0.114 REF.	
L2	1.400	1.700	0.055	0.067
L3	1.600 REF.		0.063 REF.	
L4	0.600	1.000	0.024	0.039
$\Phi$	1.100	1.300	0.043	0.051
$\theta$	0°	8°	0°	8°
h	0.000	0.300	0.000	0.012
V	5.250 REF.		0.207 REF.	

## TO-252-2L Suggested Pad Layout

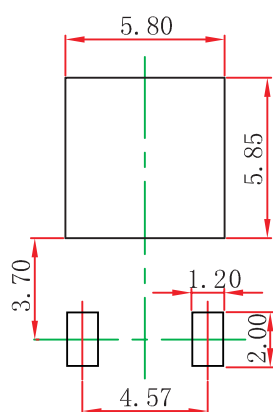

- Note:
1. Controlling dimension: in millimeters.
  2. General tolerance:  $\pm 0.05$  mm.
  3. The pad layout is for reference purposes only.

# TO-252-2L Tape and Reel

## TO-252 Embossed Carrier Tape

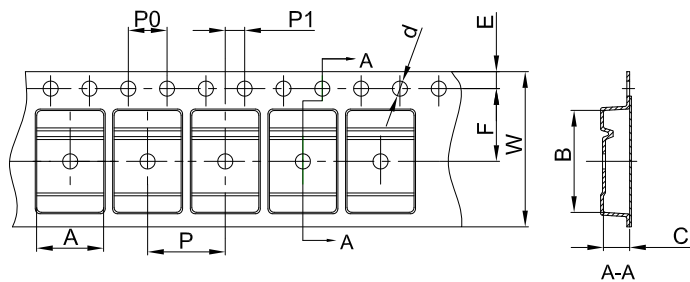

### Packaging Description:

TO-252 parts are shipped in tape. The carrier tape is made from a dissipative (carbon filled) polycarbonate resin. The cover tape is a multilayer film (Heat Activated Adhesive in nature) primarily composed of polyester film, adhesive layer, sealant, and anti-static sprayed agent. These reeled parts in standard option are shipped with 25,00 units per 13" or 33.0 cm diameter reel. The reels are clear in color and is made of polystyrene plastic (anti-static coated).

Dimensions are in millimeter										
Pkg type	A	B	C	d	E	F	P0	P	P1	W
TO-252	6.90	10.50	2.70	Ø1.55	1.75	7.50	4.00	8.00	2.00	16.00

## TO-252 Tape Leader and Trailer

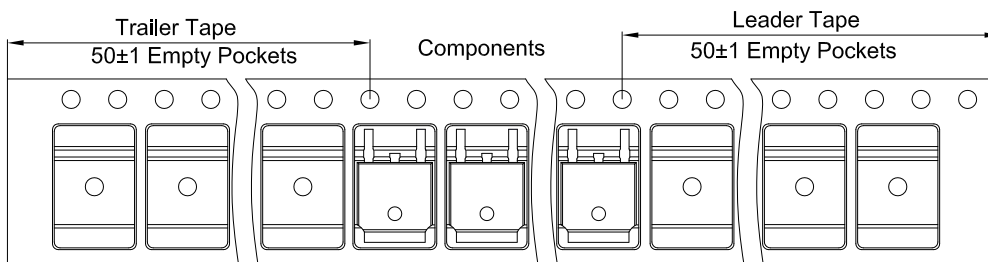

## TO-252 Reel

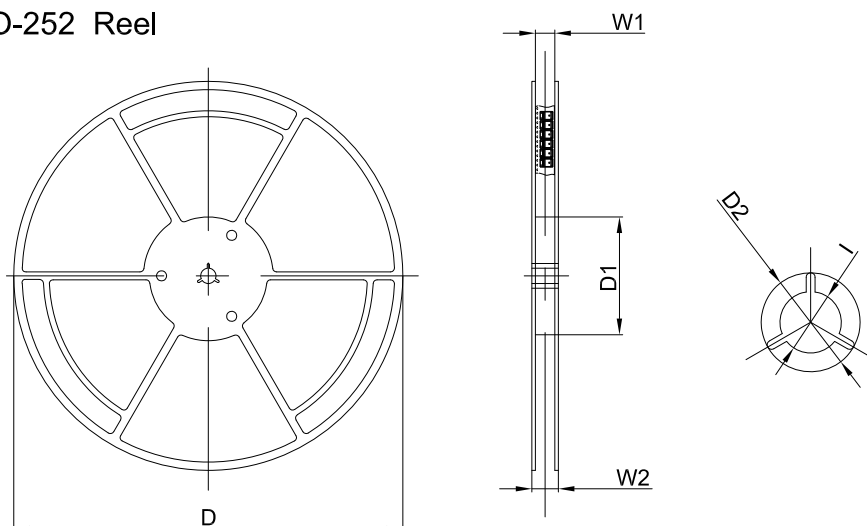

Dimensions are in millimeter						
Reel Option	D	D1	D2	W1	W2	I
13" Dia	330.00	100.00	Ø21.00	16.40	21.00	Ø13.00

REEL	Reel Size	Box	Box Size(mm)	Carton	Carton Size(mm)	G.W.(kg)
2,500 pcs	13inch	2,500 pcs	340×336×29	25,000 pcs	353×346×365	